

COMPLIANCE	UL 2416, NWIN ANSI/EIA RS-310D IEC60297-2 DIN41494; Part 1 DIN41494; Part 7
LOADING CAPACITY	250 lbs

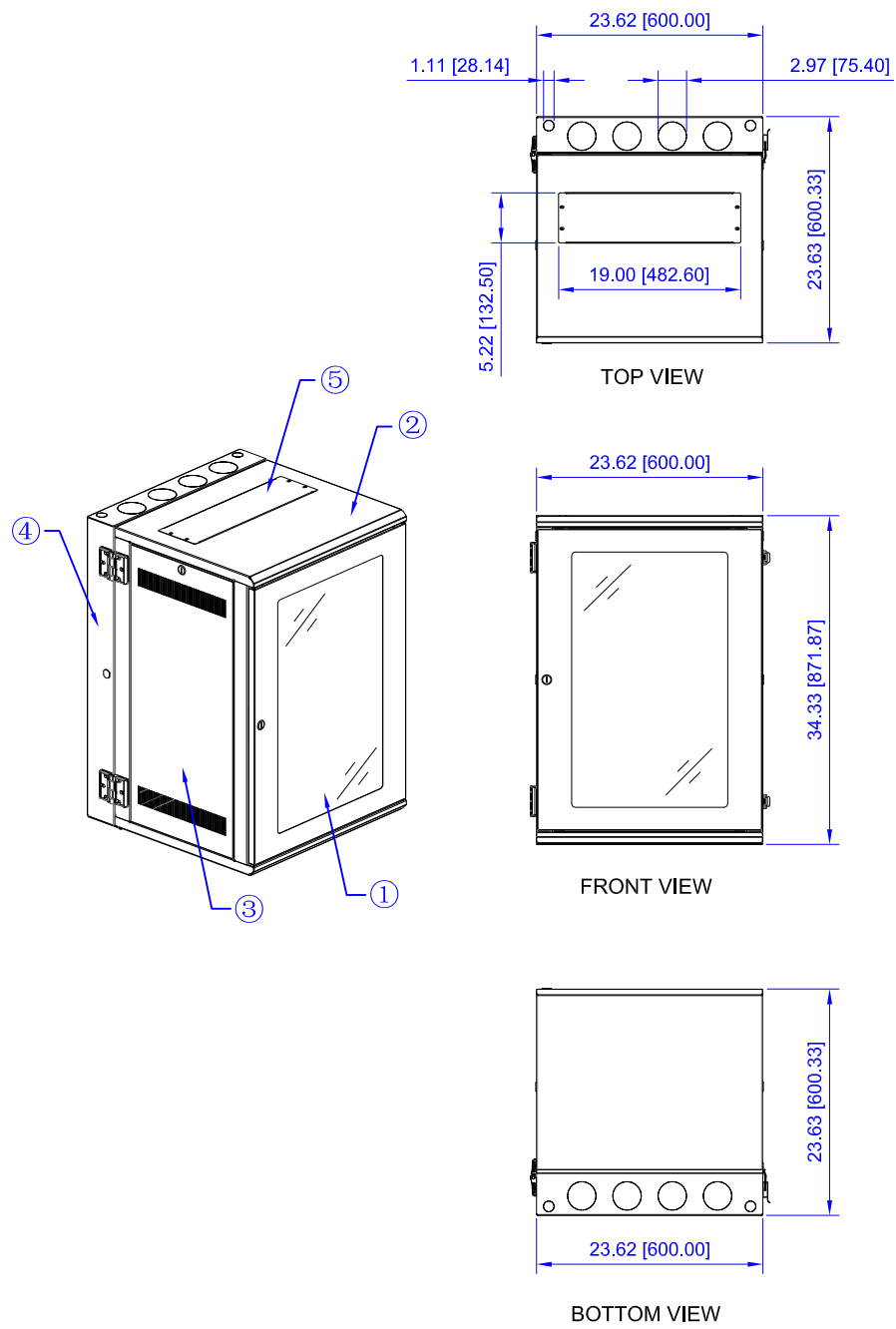

NO	QTY	NAME	MATERIAL	THICKNESS
5	1	3U Removable Panel	Steel	18 gauge
4	1	Rear Door	Steel	14 gauge
3	2	Removable Side Panel	Steel	19 gauge
2	1	Top	Steel	14 gauge
1	1	Front Door	Steel with Acrylic Window	18 gauge

ITEM NO.		VW4-6181*		VERICOM [®]
DESCRIPTION 18U x 24"D HIGH DENSITY WALL CABINET				
DATE	SCALE	SHEET	REV	
10/29/20	none	1 of 1	2	

*VW4-6181 replaces RWCHW18

All dimensions in inches [mm]