



Wall Mount Ground Bar Kit



Description

This wall mount ground bar provides a central bond location for ICT systems/equipment and the building's ground system. The 10" x 2" x 0.25" bar is 99.9% pure C11000 electrolytic tough-pitch copper and includes (16) 1/4" holes with 5/8" vertical and 1" horizontal spacing. Thermoset polyester standoff insulators and stainless-steel mounting brackets offset the ground bar 2.5" from the mounting surface.

Additional sizes and configurations are available on request.

Technical Illustration

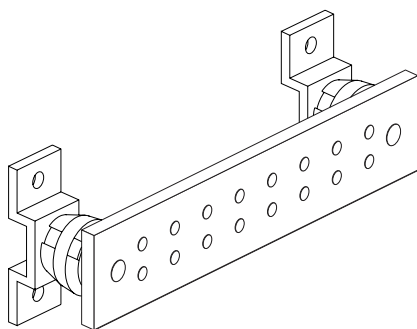
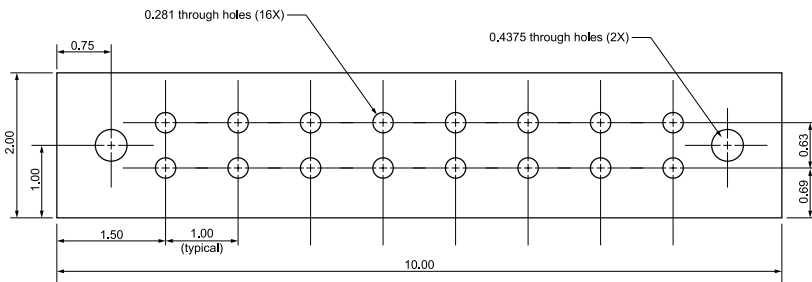

TECHNICAL SHEETS ARE SUBJECT TO CHANGE WITHOUT NOTICE.

REV.20250113.2

Product Specifications

**Product Type:** Wall Mount Ground Bar Kit

**Ground Bar Material:** 99.9% Pure C11000 Electrolytic Tough-Pitch Copper

**Dimensions (HxWxD):** 10" x 2" x 0.25"

**Standoff Insulator Material:** Thermoset Polyester

**Mounting Brackets Material:** Stainless Steel

**Quantity Per Package:** 1 Kit

Ordering Information

Item #	Description
RAGB102	Wall Mount Ground Bar Kit