

COMPLIANCE

UL 2024
UL 94 V-0

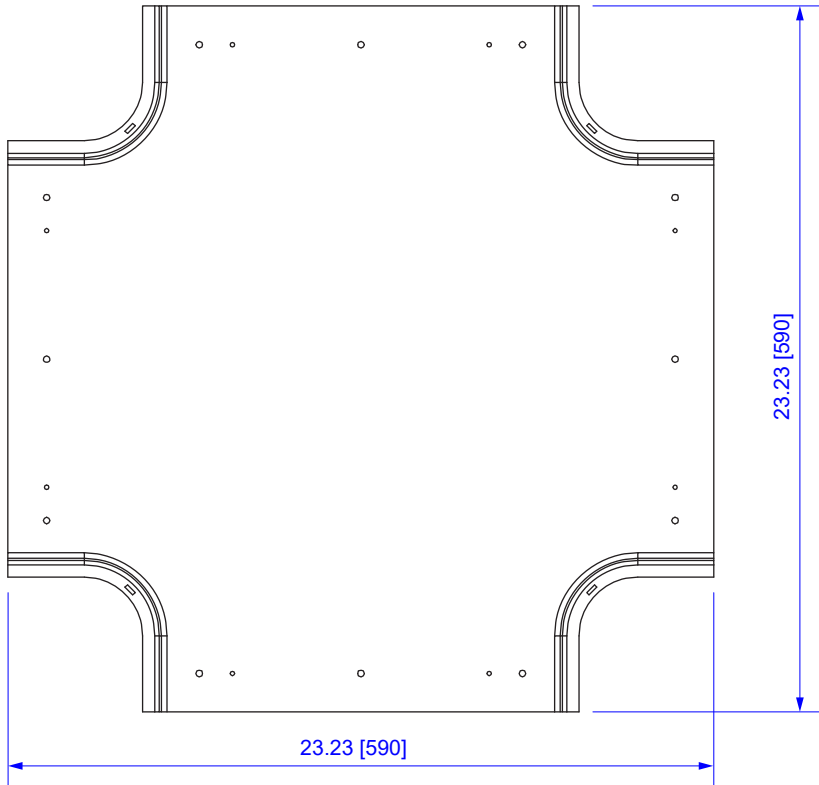

TOP VIEW

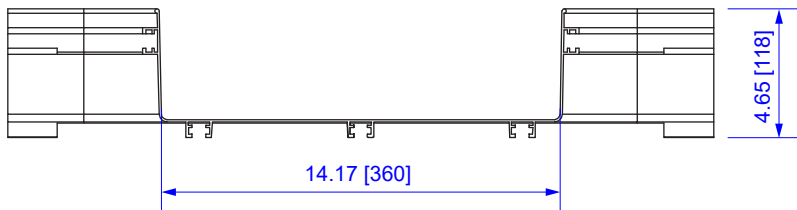
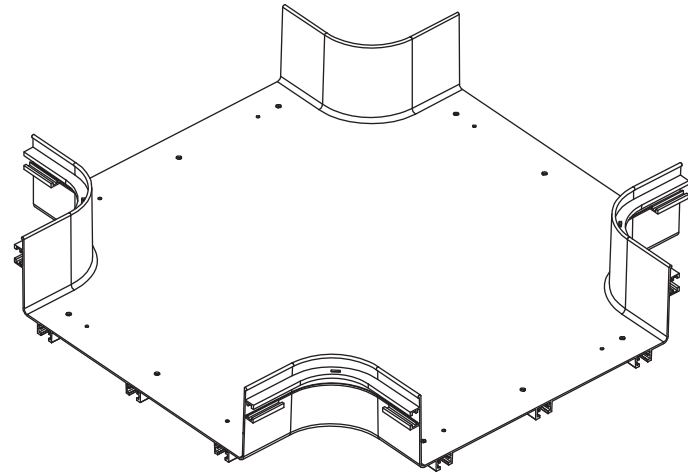

FRONT VIEW

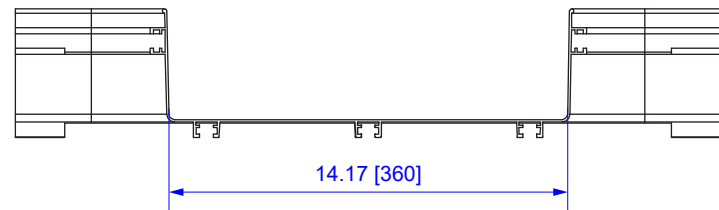

SIDE VIEW

All dimensions in inches [mm]

ITEM NO.	VCT-360HC1						
DESCRIPTION	15" HORIZONTAL CROSS						
DATE	07/22/2020	SCALE	none	SHEET	1 of 1	REV	